

DUNAVOX
THE WINE COOLING EXPERT

DUNAVOX Spirit

EN USER MANUAL v4.0-2026

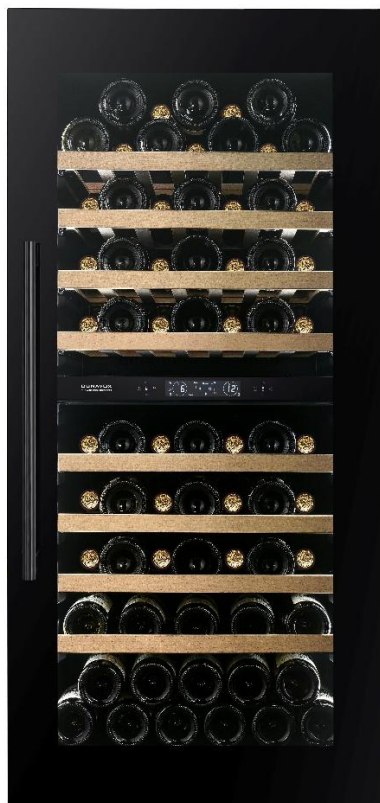

PREFACE

Dear customer,

Thank you for buying this appliance and putting your trust in Dunavox. We have designed this product with the greatest care and hope it will be proud and long-term addition to your house. If you have any questions about your appliance, please let us know, we are happy to help you!

DUNAVOX Spirit

- Door handle
- LCD touch screen
- WIFI + Smart App
- Integrated ventilation system
- Telescopic wooden shelf
- Multi LED light

Spirit products

DVS-19.50B

DVS-19.50SS

DVS-19.50C

DVS-19.50MB

DVS-25.65DB

DVS-25.65DSS

DVS-25.65DC

DVS-25.65DMB

DVS-44.120DB

DVS-44.120DSS

DVS-44.120DC

DVS-44.120DMB

DVS-70.185DB

DVS-70.185DSS

DVS-70.185DC

DVS-70.185DMB

TABLE OF CONTENTS

PAGE NUMBER

1. About this document	1
1.1. Language	1
1.2. Relevant documentation	1
1.3. Used symbols	1
2. Product Description	1
2.1. Conformity	1
3. Safety	2
3.1. Intended use	2
3.2. Intended users	2
3.3. Safety instructions	2
4. Transport and storage	3
4.1. Transport	3
4.2. Storage	4
5. Installation	4
5.1. Before installing and using your new appliance	4
5.2. Important safety instructions	4
5.3. Installation of the wine cabinet	5
5.4. Choosing a location	6
5.5. Preparing the appliance for installation	6
5.6. Connecting the power supply	7
5.7. Placing the appliance	7
5.8. Reversing the door direction	7
5.9. Fix to cabinet	7
5.10. Finishing the installation	8
6. Operating the appliance	8
6.1. Power ON/OFF button	8
6.2. Lock button	8
6.3. Function switch button	8
6.4. Function setting button	9
6.5. Temperature setting	9
6.6. Operating mode setting page	9
6.7. Light mode setting page	9
6.8. Light brightness setting page	10
6.9. Light colour setting page	10
6.10. Choice between °C/F	10
6.11. WIFI usage steps	10
6.12. Network interface	10
7. Shelves	11
7.1. Rails installation	11
8. Door	12
8.1. How to change the door opening angle	12
8.2. Installing the handle	13
9. Temperature	13
9.1. Zones	13
9.2. Controlling the temperature	13
9.3. Storing wine	14
9.4. Adding a humidity box (optional)	14
10. Energy saving	14
11. Care and maintenance	15
11.1. Cleaning	15
11.2. Defrosting the appliance	15
12. Power failure	16
13. Vacation time	16
14. Moving the wine cooler	16
15. Frequently asked questions	16
16. Disposal	18
17. Warranty	18

1. ABOUT THIS DOCUMENT

This manual is applicable to all Spirit models from Dunavox. If chapters are only applicable to some models, this will be mentioned in the title or at the beginning of the chapter.

Read and understand this manual before using the product. Carefully store this manual for future reference.

We reserve the right to change the parameters without prior notice.

1.1. Language

This manual is originally written in English. All other language versions are translations of the original text. If your preferred language is not available in printed version, please visit our website and search for your corresponding model to download the user manual in the required language.

1.2. Relevant documentation

The following documentation is available for this appliance:

Document	Location
User manual	This document
Energy label	Packed in the appliance
Installation drawing	

1.3. Used symbols

This manual contains safety instructions. Ignoring these instructions may lead to injury or damage to the appliance. Each safety instruction is indicated with a signal word. The signal word corresponds with the level of risk of the described hazardous situation.

WARNING!	This symbol indicates a hazardous situation which, if not avoided, could result in death or serious injury.
CAUTION!	This symbol indicates a hazardous situation which, if not avoided, could result in minor or moderate injury.
NOTICE	This symbol indicates a situation which, if not avoided, could result in damage to the product.

Other symbols in this manual do not refer to safety.

Tip!	This symbol indicates a tip that is useful for some users.
-------------	--

2. PRODUCT DESCRIPTION

This appliance is a high-quality wine cooler with a premium look and feel. The appliance is equipped with a dynamic climate mode which is ideal for storing wine bottles for a long period of time.

The following table shows the number of zones and the bottle capacity per model.

	Spirit			
	19	25	44	70
Number of zones	1	2	2	2
Bottle capacity	19	25	44	70

See appendix 1 for the complete list of specifications.

2.1. Conformity

This appliance is designed and tested according to the following regulations and directives:

LVD 2015/35/EU
EMC 2014/30/EU
ERP 2009/125/EC
RoHS 2011/65/EC
CB Certificate
CE Certified

3. SAFETY

3.1. Intended use

- This appliance is intended for storing wines at their optimal temperature.
- This appliance is intended to be built in or undercounter (DVS-19.50B, DVS-19.50SS, DVS-19.50C, DVS-19.50MB, DVS-25.65DB, DVS-25.65DSS, DVS-25.65DC, DVS-25.65DMB, DVS-44.120DB, DVS-44.120DSS, DVS-44.120DC, DVS-44.120DMB)
- The appliance is intended for use in household environments.
- The appliance is for indoor use only.
- This appliance is intended to be used for the storage of wine.

3.2. Intended users

This appliance can be used by children aged 8 years and above and people with reduced physical, sensory or mental capabilities or lack of experience and knowledge if they have been given supervision or instruction concerning use of the product in a safe way and understand the hazards involved. Children shall not play with the product. Cleaning and user maintenance shall not be done by children without supervision.

3.3. Safety instructions

WARNING!

Risk of electric shock. When the appliance is connected to the mains it contains a high voltage.

- Switch off the fuse of the power outlet before connecting the appliance to the mains.
- Earth the appliance.
- Switch off the fuse of the power outlet before performing maintenance.
- Do not move the appliance when the appliance is connected to an active power outlet.
- Do not connect the appliance to a power outlet when the power cord is damaged. If the power cord is damaged, it must be replaced by the manufacturer, or an authorized service centre.
- Do not connect the appliance to a faulty power outlet.
- Keep the appliance and the power cord away from water or moisture.
- Do not unplug the appliance by pulling on the cable. Always grasp the connector and pull.
- Do not unplug the appliance with wet hands.
- Do not locate multiple power outlets or extension cords behind the appliance.

WARNING!

Refrigerant is highly flammable! Refrigerant can cause fire when in contact with flames or sparks.

- Do not operate the appliance in the presence of explosive or flammable fumes.
- Do not operate the appliance when the refrigerant circuit is damaged.
- If refrigerant has leaked out of the appliance:

- Avoid any fire or sparks.
- Switch off the fuse of the power outlet of the appliance.
- Air the room in which the appliance is located for several minutes.
- Contact Dunavox for advice.

- Do not use mechanical devices to accelerate the defrosting process.

WARNING!

Risk of suffocation! Children playing with the packaging material can lead to injury. Keep the packaging out of reach of children.

CAUTION!

The appliance is heavy. Carrying and moving the appliance on your own can cause injury. Always lift and move the appliance with two people.

CAUTION!

The appliance is not built to be repaired by the user. Attempts to repair the appliance can lead to injury and damage to the appliance, and voids the warranty:

- Do not repair or replace any part of the appliance unless it is specifically recommended in this manual.
- Do not use accessories not recommended by the manufacturer.
- Do not use other electrical appliances inside the appliance.

NOTICE

External heat sources can influence the performance of the appliance:

- Do not install the appliance in direct sunlight.
- Do not install the appliance next to heat sources such as ovens, stoves, heaters, and radiators.

NOTICE

The ventilation cannot work properly when the ventilation grids are covered. The appliance can overheat. Do not cover the ventilation grids.

NOTICE

Storing open bottles in the appliance can cause leakage and mold. Do not store bottles that have been opened.

NOTICE

Multiple wine bottles can be heavy and can influence the centre of gravity of the appliance and cause the appliance to tilt:

- Pay attention to the placement of bottles in the appliance:
 - Do not slide out more than one loaded rack at once.
 - If a rack is loaded with more than one layer of bottles, do not slide out the rack.
 - Try to distribute the bottles evenly throughout the appliance.

4. TRANSPORT AND STORAGE

The transport and storage must comply with the following climate conditions:

Ambient temperature	1 -40 °C
Ambient humidity	< 95% (not condensing)

4.1. Transport

Keep the following things in mind when transporting the appliance:

- Transport the appliance in the original packaging.
- Transport the appliance with two people.
- Do not tilt the packaging more than 45°.

If the appliance is already unpacked, make sure to:

- Lock the door in closed position with tape.
- Protect the outside of the appliance. Use soft, thick cloth.

4.2. Storage

Store the appliance in the original packaging.

5. INSTALLATION

5.1. Before installing and using your new appliance

WARNING!

Before powering up the appliance, please open the door for 5 minutes to ventilate the cabinet.

- Read through the instructions supplied with the appliance – failure to install or use this appliance in accordance with the instruction book may invalidate any warranty.
- The manufacturer does not accept any liability for damage caused through improper use, or incorrect installation.
- Do not install this appliance if it has been damaged during transportation. This includes the plug and supply cord.
- Please keep these instructions in a safe place for future reference.

Note: This appliance is intended to be used exclusively for the storage of wine.

5.2. Important safety instructions

- To prevent damage to the door and door gasket, make sure the door is fully opened before pulling out any shelves.
- Do not move the wine cooler when it is loaded with wine, you might distort the appliance.
- If the power lead becomes damaged it should only be replaced by the manufacturer or a suitably qualified person.
- Never allow children to operate, play with, or crawl inside the appliance.
- Never clean appliance parts with flammable fluids.
- All electrical repairs must be carried out by a qualified service engineer. Inadequate repairs may result in a major source of danger for the user and invalidate any warranty.
- Never store anything dangerous inside the appliance, such as combustibles, explosives, strong acid or alkali etc.
- Do not store or use gasoline or any other flammable vapours and liquids in the vicinity of this or any other appliance. This can create a fire hazard or explosion.

Warning: Do not allow the refrigerant circuit to become damaged while using or installing the appliance. Should it become damaged, do not use the appliance until you are instructed to do so by a service engineer. Refrigerant can ignite or cause damage to the eye when leaking.

- Always remember to unplug the appliance before cleaning. When disconnecting from the electricity supply, pull the plug, not the power cord.
- Do not use anything electrical inside the Wine Cabinet.
- Always keep any ventilation openings clear of obstruction. Should they become blocked, clear them straight away.
- Make sure that the plug is in an accessible place when installation is complete.
- Only use this appliance for domestic purposes in accordance with these instructions. The wine cooler is suitable for storing wine (or other bottled beverages). It is not suitable for storing fresh or frozen foods.

- This appliance can be used by children aged 8 years and above and persons with reduced physical, sensory or mental capabilities or lack of experience and knowledge if they have been given supervision or instruction concerning use of the appliance in a safe way and understand the hazards involved. Children shall not play with the appliance. Cleaning and user maintenance shall not be made by children without supervision.
- The refrigerant of these appliances is R600a, flammable and explosive articles should not be put in or near the cabinet, to avoid the fire or explode caused.



5.3. Installation of your wine cabinet

- Remove the exterior and interior packing.
- **Note:** Before connecting the Wine Cabinet to the power source, let it stand upright for approximately 24 hours. This will reduce the possibility of a malfunction in the cooling system from handling during transportation.
- Fixing the handle is a necessary step before completing the installation
- Clean the interior surface with lukewarm water using a soft cloth.
- To level your Wine Cabinet, adjust the front levelling foot at the bottom of the Wine Cabinet.
- Locate the Wine Cabinet away from direct sunlight and sources of heat (oven, stove, heater, radiator, etc.). Direct sunlight may affect the acrylic coating, and heat sources may increase electrical consumption. Extreme cold ambient temperatures may also cause the unit not to perform properly.
- Avoid locating the unit in moist areas.
- The Wine Cabinet should be positioned where the ambient temperature is between 16°C and 38°C. If the ambient temperature is above or below this range, the performance of the unit may be affected. Placing the appliance in extreme cold or hot conditions may cause the interior temperatures to fluctuate. The range of setting temperatures may not be reached.
- Plug the Wine Cabinet into an appropriate socket. Should the plug require changing, use the instructions as given in the Electrical Requirements section.
- Switch off the fuse of the power outlet before connecting the appliance to the mains.
- Connect the appliance to an earthed socket
- Switch off the fuse of the power outlet before performing maintenance.
- Do not connect the appliance to a power outlet when the power cord is damaged.
- Do not connect the appliance to a faulty power outlet.
- Keep the appliance and the power cord away from water or moisture.

Note: The glass door is bigger than the appliance and breaks when the appliance is put on floor without legs. Do not place the appliance directly on the floor when it is not supported by leg or external support.

Note: The ventilation cannot work properly when the ventilation grids are covered. The appliance can overheat. Do not cover the ventilation grids.

Note: Storing opened bottles in the appliance can cause leakage and mold in the wine cooler. Do not store bottles that have been opened.

Note: Always fix the appliance to the cabinet.

The installation process of the appliance consists of the following steps:

Built into a column
Choosing a location
Preparing the appliance for installation
Connecting the power supply
Placing the appliance
Reversing the door direction (optional)
Finishing the installation

The following chapters give more explanation about each step.

5.4. Choosing a location

NOTICE

External heat sources can influence the performance of the appliance. Do not install the appliance:

- In direct sunlight
- Next to heat sources such as oven, stove, heater or radiator.

The installation room must meet the following conditions:

Operating temperature	16 – 38 °C
Operating humidity	< 95% (not condensing)
Air volume	> 1 m ³ per 8 q of coolant

Keep in mind that installation in open plan kitchens or against partition walls can increase the noise pollution emitted by the appliance.

Tip! You can also find the installation drawing on www.dunavox.com.

The appliance can be built in. The installation location must meet the following conditions:

- Not directly next to or above an oven.
- Bottom surface is strong enough to support the loaded appliance.
- Dry, stable and flat surface.
- Close to a separated power outlet (220- 240 VAC, 50 Hz).

5.5. Preparing the appliance for installation

1. Remove all exterior and interior packaging.

Tip! The product is heavy and can be hard to move over greater distances. We recommend unpacking the product on the installation location.

2. Check if all contents in the packaging are present and undamaged. The package should include 1x Dunavox wine cooler, 1x handle, 1x user manual and 1x energy label. If parts are missing or damaged, contact your supplier.
3. Use warm water and a soft cloth to clean the interior of the appliance.

Tip! The inside of the appliance may have residual odour at first. The odours disappear when the appliance is operating.

4. Let the appliance stand upright for at least 24 hours. During this time, you can keep the door of the appliance open to let residual odours escape.
5. Place the appliance in front of the installation location. Keep 0.5m space between the appliance and the cabinet for electrical installation. The appliance is now ready for electrical installation.

WARNING!

Risk of electric shock. When the appliance is connected to the mains it contains a high voltage:

- The electrical installation must comply with local and national requirements.
- The electrical installation must be done by a qualified and competent person.
- Do not move the appliance when the appliance is connected to an active power outlet.
- Do not connect the appliance to a power outlet when power cord is damaged. If the power cord is damaged, it must be replaced by the manufacturer, or an authorized service centre.

5.6. Connect the appliance to the power supply:

1. Switch off the fuse of the power outlet.
2. Plug the power cable into the power outlet. Make sure to earth the appliance.
3. Switch the fuse of the power outlet back on.
4. Check if the appliance is switched on.

If the appliance does not switch on, do the steps in this chapter again. If the appliance is still not working, contact your supplier. Switch off the fuse of the power outlet to safely continue with the installation.

5.7. Placing the appliance

1. Make sure the electrical installation is finished before the appliance is built in.
2. Adjust the legs until the appliance stand on all 4 feet and is level and stable.
3. Slide the appliance into the cabinet. Make sure:
 - The power cable is not trapped under the appliance.
 - The appliance does not touch the back wall.
 - The appliance stands in the middle of the cabinet.
 - There is at least 5mm free space at the top of the appliance.

Check again if the appliance is level and stable. If not, adjust the legs until the appliance stands on all 4 feet and is level and stable.

5.8. Reversing the door direction (Optional)

If desired, the door direction can be reverse after the appliance is installed. We recommend reversing the door direction with two people.

WARNING!

The door is made of glass and can break when it falls. When reversing the door direction, let another person support the door when unscrewing the hinges.

For further information go to chapter 8.

5.9. Fix to cabinet

The appliance must be fixed to the cabinet to prevent it from moving inward in the column when the door is repeatedly opened (pushed).

1. The fixation holes are located above and below the door.
2. Fix the appliance to the cabinet with 4 screws.

5.10. Finishing the installation

1. Switch on the fuse of the power outlet.
2. Check if the appliance is switched on. You can now use the appliance.

Tip! When using the appliance for the first time we recommend waiting 2 to 3 hours before placing the bottles into the appliance to allow the appliance to reach the set temperature.

6. OPERATING THE APPLIANCE

NOTICE

Risk of damage to your appliance. Do not switch on the appliance directly after is switched off. Wait 5 minutes before restarting the appliance.

The controls of your wine cooler

For DVS-19.50

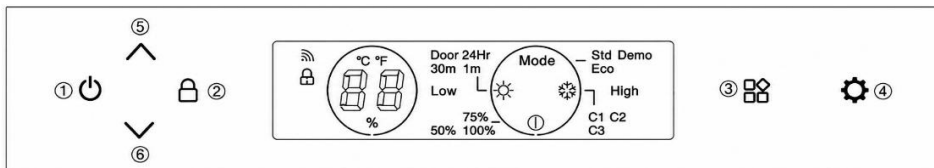

For DVS-25.65, DVS-44.120, DVS-70.185

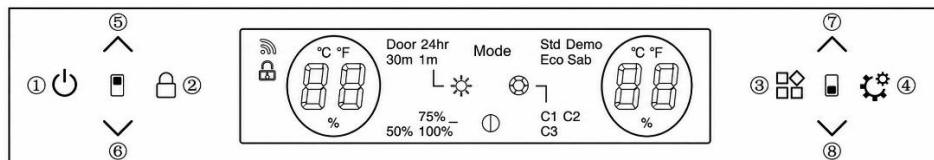



6.1. Power ON/OFF button (1)

The system default power ON after plug in. Long press this button 3 seconds, will have a beeping sound, the product power OFF. Slightly press this button, will have a beeping sound, the product power ON.

6.2. Lock button (2)

In normal mode (non-fault), the system default unlocks after power on product.

Long press  button 3 seconds, will have a beeping sound. The system enters Lock mode to lock control panel. The system will not have action when press buttons under Lock mode.

Long press  button 3 seconds under lock mode, will have a beeping sound, the control panel unlock.

6.3. Function switch button (3)

The system has 4 function icons:

System settings

Mode

Light brightness settings



Light colour settings



Light duration settings



Press the  button to switch between the functions during the icon blinks. If there's no action after blink 5 times, the system will exit function switch mode.

6.4. Function setting button ④

This button will have action only when function icon blink. Use this button to switch between functions.

6.5. Temperature setting

⑤ ⑥ upper zone temperature adjust buttons

⑦ ⑧ lower zone temperature adjust buttons

 **Temperature increase button**

Press the button once will have a beeping sound, temperature will increase 1°C.
When the set temperature reaches the set upper limit, the set temperature will not change.

 **Temperature decrease button**

Press the button once will have a beeping sound, temperature will decrease 1°C.
When the set temperature reaches the set lower limit, the set temperature will not change.

Temperature control range

- FOR DVS-19.50: 5-18°C

- FOR DVS-25.65; DVS-44.120; DVS-70.185: Upper zone: 5-10°C, Lower zone: 10-18°C

Factory default setting temperature

- FOR DVS-19.50: 12°C

- FOR DVS-25.65; DVS-44.120; DVS-70.185: Upper zone: 6°C, Lower zone: 12°C



6.6. Operating mode setting page

Press **Mode** icon, when is blinking press  button to switch between Std//Eco/Demo mode.



1. Std (Standard mode): The system default "Std" mode after power on product.
2. Eco (Energy saving mode): After entering Eco mode, the internal light will turn off after 3 seconds and the screen will go off 20 seconds after the door is closed.
3. Demo: After entering the Demo mode, the compressor will stop working. All other functions remain operational. Such as the push-to-open door mechanism and the lighting. This mode is ideal for showrooms or exhibitions to display the wine cooler.

The selected mode will blink 5 times to confirm the setting.



6.7. Light mode setting page

Press the  icon, when is blinking press the  button to set up the inner light duration. The options are “Door, 1 minute, 30 minutes or 24 hours”. The selected light button will blink 5 times to confirm the selected option. The system default is the “Door” light is on when the door is open, and off when is closed. With all duration settings the brightness is 100% if the door is opened but the brightness is lower if the door is closed. Brightness depends on brightness level set up.

6.8. Light brightness setting page



Press the  icon, when is blinking press the  button to switch between 50% / 75% / 100% brightness level. The selected level will blink 5 times to confirm the setting. The system default is 75% brightness after power on the appliance.

6.9. Light colour setting page

Press the  icon, when is blinking press the  button to switch between C1/C2/C3 colours. The selected colour will blink 5 times to confirm the setting. The system default is C1 colour. C1 is white, C2 is blue and C3 is orange.

6.10. Choice between °C/F on display

Celsius and Fahrenheit switch:

Long press  and  of upper zone or lower zone together for 3 seconds, temperature display will switch between °C and F.

6.11. WIFI usage steps

1. Scan the code to download the “smart life” APP and install it on your phone.



2. Register a personal account and log into your home WIFI network.

3. After connecting the power, press and hold the  button for 3 seconds and until four times beep sound. The system enters the network matching status. The button backlight start shinning.

4. Click “+” on the APP page to “Add Device”. The APP will automatically search the devices and attempts to connecting.

5. The device icon will pop up when APP success to searching the device. Click the icon and enter the Wifi password. Then waiting for the complete connecting.

6. After the network is success connecting, the backlight stops shinning. The APP enter the wine cooler control main window. You can use the APP now. If the connection fail, please check the WIFI network and try to connect again.

6.12. Network interface

1. Bluetooth (Bluetooth LE) interface: before the network allocation, the device will turn on the Bluetooth function by default and its main function is used for proximity device search and initial connection, when you are ready to network the device, mobile phones and other smart devices can quickly discover the device via Bluetooth and establish a preliminary communication link to prepare for the subsequent Wi-Fi networking process.

2. WiFi interface: Before network allocation, the Wi-Fi interface of device is not connected, but in configurable listening mode. It is always listening to the Wi-Fi signals in the surrounding environment and waiting for the user's command sent through the mobile app. Once it receives the correct assignment to connect to the specified Wi-Fi network. The device only supports Wi-Fi networks in the 2.4GHz band, which is more suitable for the stable connection to smart devices in the home enrolment Service.

3. Device broadcasting service: Device continuously broadcasts its own device information via Bluetooth, including device name, device type and unique identifier. The broadcast information will be received by the surrounding Bluetooth smart devices, so that users can quickly identify and select the equipment that needs to be connected to the network in the mobile phone APP.

4. Networking service: Whether it is establishing initial connection with mobile phone APP via Bluetooth or subsequent network configuration via Wi-Fi, the device provides corresponding networking service. The router Wi-Fi network name (SSID) and password are transmitted from APP to the mobile phone APP via Bluetooth. During the Wi-Fi distribution process, the device will try to connect to the specified Wi-Fi network according to the received distribution information and give feedback to the mobile phone APP about the progress and result of distribution.

7. SHELVES

- According to the actual configuration of your product, please check the relative Remove or Replace Racks.
- To prevent damaging the door gasket, make sure to have the door all the way open when pulling shelves out of the rail compartment.

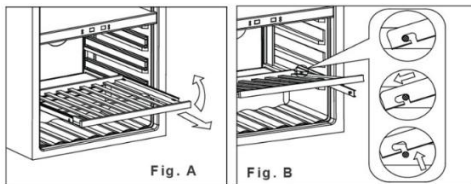

1. Fully extend the shelf you wish to remove (Fig. A)
2. Lift the front of the shelf up (Fig. A)
3. Holding the shelf track, push the shelf in, then up to release from the rear dampers (Fig. B)

7.1. Rails installation



1. Place the rails on the screw holes (marked with red on 1st picture)
2. Fix the rails to the cabinet in both screw holes (screws included to the rails)
3. Fix the rails on both side of the cabinet.
4. Install the shelf according to the description in "Shelves"

8. DOOR

8.1. How to change the door opening angle

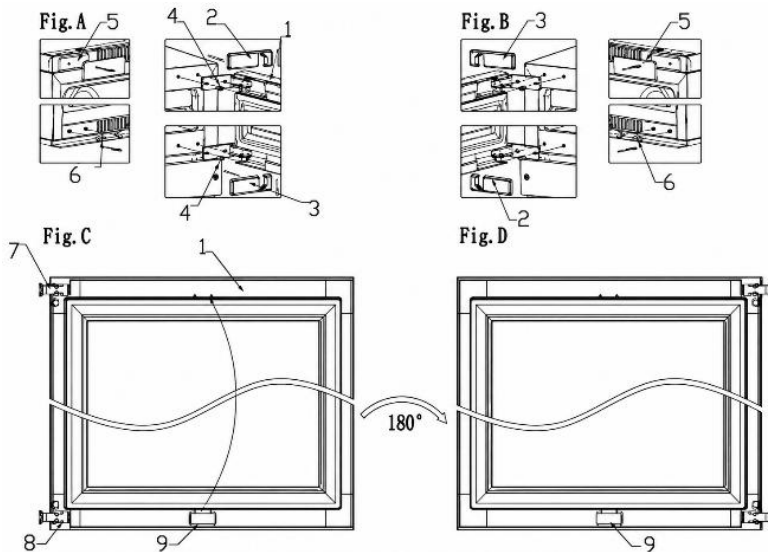

1. door; **2.** upper door hinge cover; **3.** lower door hinge cover; **4.** screw **5.** decorative pieces (22 is for decorative nails); **6.** decorative nails; **7/8.** door hinge; **9.** door lamp press

1. Open the door and remove the decorative nails (5) on the upper left side and the decorative nail (6) on the lower left side (Fig A).
2. Pull the right door hinge cover (2) forward and upward and then pull the right lower door hinge cover (3) forward and downward (Fig A).
3. Remove all screws (4) from the upper and lower hinge and then remove the door (Fig A).
4. Press the door lamp (9), remove and install it on the upper door frame and then rotate the door 180 degrees (Fig C/D).
5. Fix the door hinge on the left side of the box with screws and tighten the screws to ensure that the door hinge is tight (Fig. B).
6. Finally, install decorative pieces (5) and decorative nails (6) in the upper right corner and lower right corner of the box (Fig. B)

Note: It takes two people to change the door.

8.2. Installing the handle

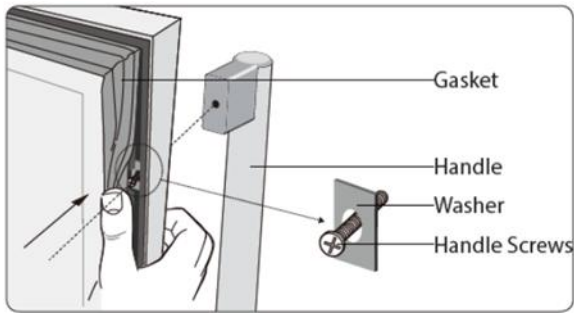

To install the door handle:

1. Open the door and pull the door gasket from the door frame to have access to the screws.
2. Place the handle over the pins on the door.
3. Fix the handle to the door with the screws. Be careful, do not fix the screws tight to avoid damage to the door.

9. TEMPERATURE

The optimal temperature depends on the type of wine:

Wine type	Optimal temperature	
Red wine	14 – 18 °C	57 – 65 °F
White wine	5 – 10 °C	41 – 50 °F
Maturing wine	11 – 14 °C	52 – 57 °F

Always check the bottle label for the optimal storage temperature of your wines.

9.1 Zones

The appliance can be equipped with multiple zones. Each zone is suitable for different kinds of wines. The displays show the current temperature in the corresponding zones.

Tip! If you want to switch the units on the display between °C and °F.

Type	Zone	Wine types	Temperature settings	
Single zone		All wine types	Depending on wine type	
Double zone	Upper zone	Champagne White wine	5 – 10 °C	41 – 50 °F
	Lower zone	White wine Red wine	10 – 18 °C	50 – 65 °F

For optimal performance, we recommend a temperature difference between the zones of at least 4 °C.

9.2. Controlling the temperature

To control the temperature settings:

1. Press one of the temperature buttons to check the set temperature. The set temperature blinks on the display.
2. Use the temperature buttons to change the temperature.

When the temperature buttons are not touched for more than 5 seconds, the display stops blinking and shows the current temperature in the corresponding zone again.

NOTICE

If the temperature on the display keeps blinking, the measured temperature deviates more than 5 °C from the set temperature. A temperature deviation of more than 5 °C could impair a wine. Check if the stored wines can handle the difference in temperature, and if not, remove the wine from the cooler until the display stops blinking.

The temperature memory function makes sure the temperature settings remain the same when the appliance switches on after a power loss.

9.3. Storing wine

The amount of wine that can be stored in the appliance depends on the size of the bottles. The capacity is an approximate maximum based on Bordeaux 750 ml bottles.

NOTICE

Multiple wine bottles can be heavy and can influence the centre of gravity of the appliance and cause the appliance to tilt. Pay attention to the placement of bottles in the appliance:

- Do not slide out more than one loaded rack at once.
- If a rack is loaded with more than one layer of bottles, do not slide out the rack.
- Try to distribute the bottles evenly throughout the appliance.

Opened bottles can cause spillage in the appliance. Only place unopened bottles in the appliance.

To store wine in your appliance, do the following:

1. Fully open the door.
2. Pull out one of the racks.
3. Place your bottle flat on the rack.
4. Push the rack back into the appliance.
5. Close the door properly.

For optimal performance of the appliance keep the following things in mind:

- If you do not have enough bottles to fill your appliance, distribute the bottles as evenly as possible through the appliance.
- Keep a gap between the wall and the bottles to allow air circulation.

9.4. Adding a humidity box (optional)

When the appliance is installed in a very dry climate (humidity below 40%) you can place a humidity box into the appliance.

Tip! Keep in mind that using the humidity box decreases the bottle capacity of the appliance.

To add the humidity box, do the following:

1. Fill the humidity box with water.
2. Place the humidity box on the shelf with runners.

10. ENERGY SAVING

The appliance is energy efficient by itself. If you want to use the appliance as efficiently as possible:

- Keep the door closed as much as possible.
- Do not change the set temperature too often.

- Switch off the appliance when it is empty for a longer period.
- The Wine Cooler should be in the coolest area of the room, away from producing appliances, and out of direct sunlight.

11. CARE AND MAINTENANCE

WARNING!

Risk of electric shock. When the appliance is connected to the mains it contains a high voltage. Switch off the fuse of the power outlet before performing maintenance.

The following maintenance tasks are needed to keep the appliance in optimal condition:

Maintenance task	Frequency
Quick cleaning	Every month
Thorough cleaning	When dirty or when not in use for longer periods of time
Defrosting	Every six months (or when the frost on the evaporator is 5mm thick)

The following chapters give instructions on how to perform these maintenance tasks.

11.1. Cleaning

NOTICE

Using unsuitable cleaning agents can damage the surfaces of the appliance. Do not use any abrasive or aggressive cleaning agents, sponges or cloths. Clean in the direction of the grain.

The display contains electrical components. Using too much water during cleaning can damage the display. Make sure to wring your cloth or sponge before cleaning the display.

To clean the appliance, do the following:

1. Turn off the power, unplug the appliance and remove all items including bottles, shelves and rack.
2. Wash the inside surfaces with warm water and mild solution.
3. Wash the shelves with a mild detergent solution. Wait until the shelves dry out before place back to the unit
4. Wring excess water out of the cloth when cleaning area of the controls, or any electrical parts.
5. Wash the outside with warm water and mild liquid detergent. Rinse well and wipe dry with a clean, soft cloth.
6. Clean the air vents with a damp and soft cloth.
7. If present, clean the humidity box under running water.
8. Clean the door with glass cleaner and a soft cloth.

WARNING!

Never power up the appliance while the interior or shelves are wet. Operating in a humid environment significantly increases the risk of mold growth. Make sure that the interior of the appliance and all accessories are completely dry before switching it on.

11.2. Defrosting the appliance

Defrosting usually takes 2-4 hours. The appliance is defrosted when all the frost from the evaporator is gone.

To defrost the appliance:

1. Switch off the appliance.
2. Remove the bottles from the appliance.
3. Leave the door open to speed up the process.
4. Place towels at the door opening of the appliance to absorb any water.
5. Switch the appliance back on.
6. If present, refill the humidity box.

12. POWER FAILURE

Most power failures are corrected within a few hours and should not affect the temperature of your appliance if you minimize the number of times the door is opened. If the power is going to be off for a long period of time, you need to take the proper steps to protect your contents.

13. VACATION TIME

Short vacations: Leave the Wine Cooler/Beverage Cooler operating during vacations of less than three weeks. If the appliance is not used for several months, remove all items and turn off the appliance. Clean and dry the interior thoroughly. To prevent odour and Mold growth, leave the door open slightly; block it open if necessary.

14. MOVING THE WINE COOLER

1. Remove all the items.
2. Take out the loose items inside the wine cooler (bottles and shelves) or fix the loose items with the foam.
3. Turn the adjustable leg up to the base to avoid damage.
4. Tape the door shut.
5. Be sure the appliance stays secure in the upright position during transportation. Also protect outside of appliance with a blanket or similar items.

15. FREQUENTLY ASKED QUESTIONS

1. The appliance does not cool enough. What to do?

Ensure the door is fully closed. Do not expose the unit to direct sunlight. Keep the ventilation grilles clean.

2. Appliance frequently switches on and off.

A wine cooler typically activates the cooling cycle every 10–15 minutes. If the compressor starts more frequently, check the following: climate conditions at the installation location; proper door closure.

If many new bottles have been loaded at once, the unit may require at least 24 hours to reach the set temperature, resulting in temporarily more frequent cooling cycles.

3. Door does not open.

Check the installation and refer to the user manual for instructions on adjusting the door opening sensor.

4. Interior light does not work.

Verify the wine cooler's settings. More information about available settings can be found in the user manual.

5. Condensation appears on the glass.

Excessive humidity in the room may cause moisture issues. This is not a malfunction of the appliance.

6. The door does not close properly.

Wine coolers may remain packed for more than six months before reaching the customer. The units are securely protected with Styrofoam on all sides and fastened with two straps to ensure a safe environment and prevent physical damage

during transport. Due to the tight packaging, the door gasket may become deformed and require adjustment. To correct this, close the door and gently warm the gasket using a hair dryer. Carefully adjust the gasket's lamellas to help them open and return to their proper shape. Check the position of the gasket and the door to ensure proper sealing. If the gasket has become loose or lost its shape after years, it can be restored again using a hairdryer. Verify that the unit is level and that all shelves are correctly installed.

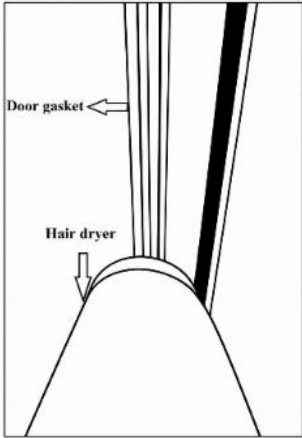

7. How to register my service request

Please use the link to register your service request: <https://service.dunavox.com/>

You need the following information to register:

- Contact details (Name, email address, phone number)
- Account details (Country of purchase, purchase date, who did you buy it from)
- Details of product (product type, serial number)
- Error description (Explanation of the error, uploading pictures of the installation is mandatory when submitting the service report form).

If you notice any unusual behaviour in your appliance, please contact your local reseller or send an email to the following email address: service@dunavox.com

16. DISPOSAL

1. Before disposing of an old appliance disconnect the plug from the main socket to ensure that the appliance is inoperative.
2. Remove the door but leave the shelves in place to prevent children climbing inside.
3. Cut off the main cable and discard it.



The symbol on the product or its packaging indicates that this product is not to be handled as general household waste but is to be taken to a recycling collection point for electrical and electronic goods. Disposal must be carried out in accordance with local environmental regulations for waste disposal. By correctly disposing of this product you are contributing to the protection of the environment and to the health of your fellow human beings. Improper disposal endangers health and the environment. Further information about the recycling of the product may be obtained from your town hall, refuse collection department or the store where you purchased the product.

If your product is defective, contact Dunavox. We can possibly repair the product or give it a second life. If you must dispose of the product, dispose the product according to the locally applicable guidelines.

When you sell the product to a new owner, make sure to add this manual or a copy of this manual.

WARNING!

When disposing of an old appliance, make sure that the pipe work does not become damaged.

17. WARRANTY

Products for domestic use carry a **24-month standard warranty**. Registration within 30 days of purchase extends the warranty by **12 months (36 months total)**.

Registration at <https://dunavox.com/product-registration>

The compressor is covered for a **further two (2) years**, giving **five (5) years total** on the compressor.

The warranty applies **only in the country of purchase**.

Claims must include **proof of purchase** and, if applicable, **proof of registration**. The warranty covers **labour, spare parts, and transport costs** necessary for repair. Removal and reinstallation of built-in appliances are the end user's responsibility. For safety reasons, on-site service is not provided for units installed higher than **2 metres** above floor level.

Exclusions:

No coverage for: transport/relocation damage; scratches/broken glass, shelves, or handles; improper installation/use; wrong power connection or unstable voltage; unauthorised repair/modification; natural disasters; aesthetic wear/discoloration; loss or spoilage of wine or other contents; general wear and tear. Dunavox is not liable for any indirect or consequential damage, including deterioration of wine or surrounding materials.

Products are covered by the official manufacturer's warranty in accordance with applicable EU consumer/product-conformity regulations. The warranty is personal to the original purchaser and non-transferable. Repair/replacement does not extend the original warranty period.

The warranty clauses and specifications are subject to change without notice.

DUNAVOX

THE WINE COOLING EXPERT

